

Aluminum valves with (left to right): Electro Pneumatic, Manual, and Motor Actuators. Stainless Steel valves also available.

### ANSI, ISO, JIS, or Special Flanges

These Vacuum Research 5 minute rebuild valves are available with virtually any flange or combination of flanges at no extra charge. Combinations of ISO on one flange and ANSI on the other are easily accommodated. Even different sizes such as 4 inch on one flange and 6 inch on the other.

### Insertable "Flangeless" Valves

It is sometimes helpful to keep the flange-to-flange dimension ("A" dimension on the dimensions pages) as short as possible. In such cases your valves can be provided with no port flanges at all and with either O-Ring grooves machined into the valve body or with a precision machined surface on the body to seal against the O-rings on your pump or chamber. Contact the factory for prices.

### Aluminum or Stainless Steel

Vacuum Research Bonnet Style valves are available in stainless steel or 6061 aluminum. Smooth surface finish gives low outgassing and fast pump down.

### High Conductance

In addition to the oversize ports used in the LPWA Series for the last 40 years, we now offer the X-LPWA Series where a 4 inch valve has a 6 inch port, an 8 inch valve has a 10 inch port, etc. Conductance values are shown on page 39.

### Fail Safe

All Vacuum Research Bonnet Style Valves can be installed for fast close on power failure and air operated valves can be manually positioned without air or electricity.

### Long Life

More than 250,000 cycles for aluminum valves. That's one cycle every 2 minutes, 24 hours/day for a year.

### SolidWorks \*.STEP Files

Contact us to obtain SolidWorks 3D \*.STEP format modeling files that plug formatted VRC valve 3-D models into your computer-aided design projects.



### Less Outgassing Than Stainless Steel

Dozens of papers show the 6000 Series aluminum used in VRC valves outgasses up to 2 orders of magnitude less than 300 Series stainless steel and of course no hydrogen. A bibliography of 70 peer reviewed papers about out-gassing compiled by Dr. M. Wong at Fermi Labs can be found at [http://home.fnal.gov/~ml-wong/outgas\\_rev.htm](http://home.fnal.gov/~ml-wong/outgas_rev.htm). See page 40 for more information

### Vacuum & Pressure

Vacuum Research valves stay sealed with vacuum or atmosphere on either side.

### Satisfaction Guaranteed

Vacuum Research has been building high vacuum valves for almost 50 years and has earned a reputation for world class product quality and customer service. If you are not satisfied with our valve just send it back.

### No Leaks

All Vacuum Research valves have total leak rates of less than 5 X 10<sup>-10</sup> std cc/sec. By total leak we mean that each completed valve is tested in a He filled bag.

### RoHS Compliant

All Valves are (RoHS) 2015/863/EU Compliant and carry the mark.

### Electric Motor, Air or Manual Actuators

All Vacuum Research gate valves are available with 3 types of actuators. Manual actuators are the least expensive. Electro-pneumatic actuators use 70 psi (4.9 kg/cm) compressed air and include the solenoid (specify the solenoid voltage that is most convenient for you). Electric motor actuators use high torque servo motors and operate from 115V or 230V, 1Ø 50 or 60 Hz. CE Mark included.

### Roughing and Gauge Ports

There are six locations for optional gauge and roughing ports described on page 43.

### Position Indicators, Limit Switches

Visual indication of valve position is included on all valves. Limit switches for remote indication are available and are described on the Optional Features pages in the Accessories & Parts section.

## Complete Rebuild in 5 Minutes.

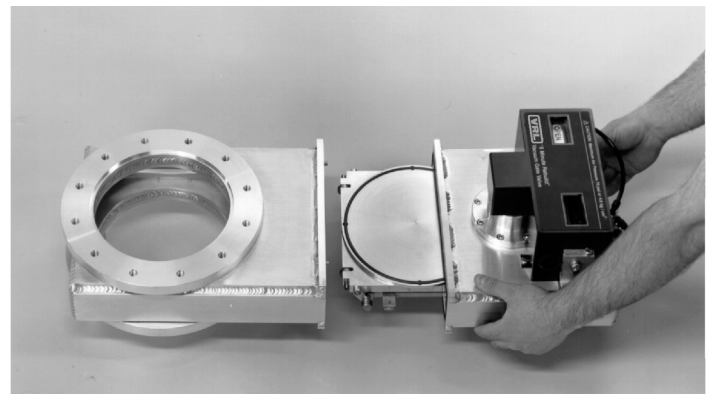

With no special tools or training you can replace every moving part in your Vacuum Research Bonnet Style Valve in 5 minutes. (Our best guys can do it in less time, but they practice.)

# Replacements for VRC 'T' Style Valves

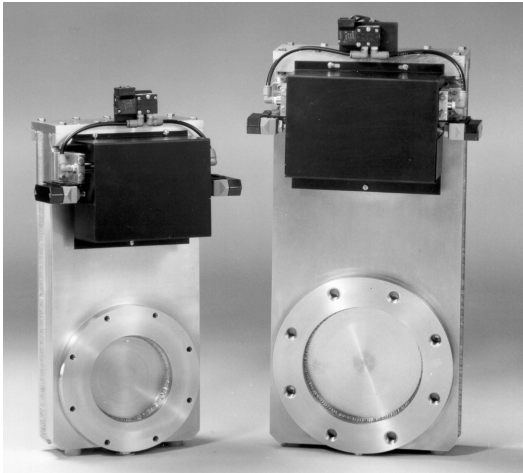

- 250,000 Cycle Rotary Shaft Seal
- Million Cycle Valves Also Available
- All Welded 6061 Aluminum Body
- All Valves (RoHS) 2015/863/EU Compliant
- Low Temperature Bake Out, 200°C
- Uses Standard ISO Centering Rings
- He Leak Less Than  $5 \times 10^{-10}$  scc/sec
- Operate Manually If Air or Power Fail
- Fail Safe Design, Close On Power Loss

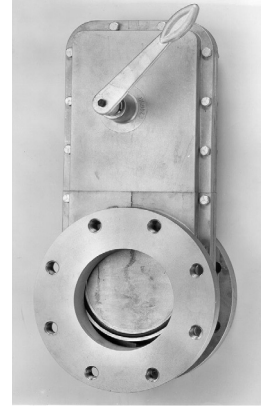

Original Cast Aluminum "T" Style Valve with manual Actuator

The old Vacuum Research "T" Valves were in production from approximately 1955 to 1980, and many are still in service. These valves were available with "T1" and "T2" flanges, and various combinations of "T1" and "T2" with necks on either or both sides.

- T1 flanges are 150 lb. ANSI with standard ports; not "large ports." That is, the 2" flange had a 2" port diameter. The 6" flange had a 6" port diameter, etc.
- T2 flanges also had standard port sizes, i.e. 2" port in 2" flange, but the T2 flanges had a smaller outside diameter, smaller bolts, smaller bolt circle, and smaller diameter flange O-rings. T2 flanges were offered in sizes from 1 inch to 6 inch.

Although out of production for 30 years and no longer supported with spare parts, we can, however, provide direct replacement valves with identical bolt circle, O-ring and flange 'A' dimension.

Other dimensions such as overall height and actuator size may be different, so please review the drawing carefully to make sure there are no interferences.

Some T1 and T2 valves were built with plain and special flanges, so you must be certain of which flanges need O-rings, the bolt size and bolt circle. For electro-pneumatic valves, be sure to verify the solenoid voltage. Since these replacement valves will be custom made to your order, they may not be returned for credit for any reason. Of course, they have our usual warranty and will be repaired for no charge if defective in any way.

## ORDERING INFORMATION

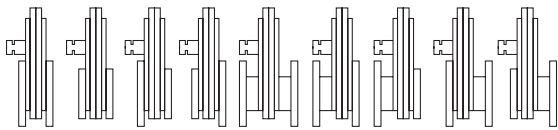

T1 T2 T3 T4 N5 TN6 TN7 TN8 TN9

### Viton® or Kalrez® or Silicone O-Rings:

Our standard Valves use a Viton® O-Ring for the gate seal and Buna-N O-Rings for all other locations. You may specify Viton® (or other materials) throughout the valve with a "V", "S", or "K" in the model number. For Viton® add the following to the price. (For Silicone or Kalrez® contact the factory for prices.)

2 & 3 in. valves .....	\$81	8 in. valves.....	\$240
4 in. valves.....	\$122	10 in. valves.....	\$313
6 in. valves.....	\$153	12 in. valves.....	\$403

### Roughing And Gauge Ports

NW-16 to NW-50 ports can be added to the valve body in a variety of locations to provide easy connections for gauge tubes or roughing lines. Refer to the Roughing and Gauge ports page in the Accessories and Parts section of this catalog for details and prices.

### Position Indicators

Remote indication of valve position is provided by these SPST and SPDT limit switches. Refer to the Optional Features pages in the Accessories and Parts section of this catalog for details and prices.

### Port Flange O-Rings and Bolt Circle

The standard configuration for replacement 'T' Style valves is O-Rings on both flanges and the bolt circle straddling the vertical centerline. No charge for other configurations.

Port Diam.	With Electro-Pneumatic Operator "EP" Suffix		With Manual Operator "EP" Suffix	
	Model No.	Price	Model No.	Price
2 inch	OP-2N-N1-T1-EP	\$2,367	OP-2N-N1-T1-M	\$2,091
	OP-2N-N1-T2-EP	\$2,645	OP-2N-N1-T2-M	\$2,365
	OP-2N-N5-T1-EP	\$2,655	OP-2N-N5-T1-M	\$2,377
3 inch	LPWA-3-N1-T1-EP	\$2,719	LPWA-3-N1-T1-M	\$2,441
	LPWA-3-N1-T2-EP	\$2,996	LPWA-3-N1-T2-M	\$2,718
	LPWA-N5-T1-EP	\$2,971	LPWA-N5-T1-M	\$2,692
4 inch	LPWA-4-N1-T1-EP	\$2,904	LPWA-4-N1-T1-M	\$2,555
	LPWA-4-N1-T2-EP	\$3,131	LPWA-4-N1-T2-M	\$2,829
	LPWA-4-N5-T2-EP	\$3,310	LPWA-4-N5-T2-M	\$2,922
6 inch	LPWA-6-N1-T1-EP	\$3,348	LPWA-6-N1-T1-M	\$2,669
	LPWA-6-N1-T2-EP	\$3,623	LPWA-6-N1-T2-M	\$3,218
	LPWA-6-N5-T2-EP	\$3,834	LPWA-6-N5-T2-M	\$3,427
8 inch	LPWA-8-N1-T1-EP	\$5,458	LPWA-8-N1-T1-M	\$4,744
	LPWA-8-N5-T2-EP	\$5,884	LPWA-8-N5-T2-M	\$5,476
10 inch	LPWA-10-N1-T1-EP	\$6,709	LPWA-10-N1-T1-N	\$6,222
	LPWA-10-N5-T2-EP	\$7,241	LPWA-10-N5-T2-N	\$6,754
12 inch	LPWA-12-N1-T1-EP	\$8,333	LPWA-12-N1-T1-M	\$7,844
	LPWA-12-N5-T2-EP	\$8,845	LPWA-12-N5-T2-M	\$8,358

# One Piece T1 and T2 Welded Aluminum Gate Valves

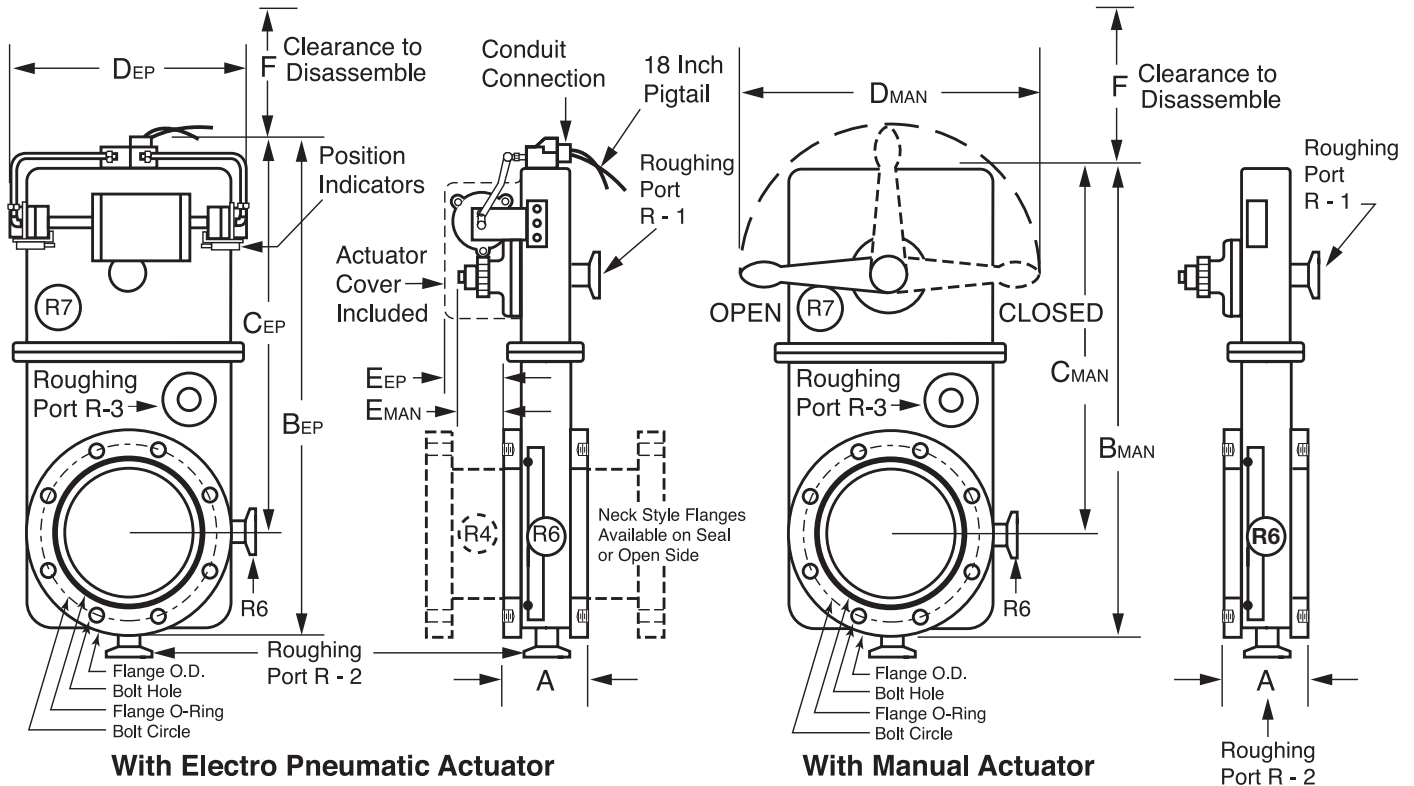

## One Piece Welded Aluminum Gate Valves, ANSI Flanges

Note: All dimensions in inches. Roughing ports and position indicator limit switches optional. Bolt holes straddle vertical centerline. O-Rings on both flanges are standard. Flanges also available without O-Rings.

These dimensions are identical to the original 'T' Style Valves								These dimensions may be different than 'T' Style									Weight (lbs)	
Nominal ANSI Size	Model No. ANSI Flange	Port Diam.	Flange O.D.	Flange O-Rings Inside Diam.	Bolt Circle	(no of bolts) x bolt size	A Flange to Flange	BMAN Manual Overall Height	BEP EP Overall Height	CEP Port CL to Top of Valve	DMAN Manual Overall Width	DEP EP Overall Width	EMAN Manual	EEP EP	F Disassy. Clearance	Net	Ship	
2 inch	OP 2 N1-T1	2	6	2 3/4	4 3/4	(4) 5/8-11	3 1/4	12 5/8	14 5/8	11 5/8	10	7 3/8	3 1/16	4 3/8	7 1/2	13	20	
2 inch	OP 2 N1-T2	2	4 3/4	2 1/4	3 5/16	(6) 1/4-20	3 1/4	12 5/8	14 5/8	11 5/8	10	7 3/8	3 1/16	4 3/8	7 1/2	13	20	
2 inch	OP 2 N5-T1	2	6	2 3/4	4 3/4	(4) Slotted	5 1/2	12 5/8	14 5/8	11 5/8	10	7 3/8	3 1/16	4 3/8	7 1/2	13	20	
3 inch	LPWA 3 N1-T1	3	7 1/2	4	6	(4) 5/8-11	3 5/16	13 3/8	15 3/8	11 5/8	10	7 3/8	3 1/16	4 3/8	7 1/2	15	22	
3 inch	LPWA 3 N1-T2	3	6	3 1/2	4 3/4	(6) 3/8-16	3 5/16	13 3/8	15 3/8	11 5/8	10	7 3/8	3 1/16	4 3/8	7 1/2	15	22	
3 inch	LPWA 3 N5-T1	3	7 1/2	4	6	(4) Slotted	5 7/8	13 3/8	15 3/8	11 5/8	10	7 3/8	3 1/16	4 3/8	7 1/2	15	22	
4 inch	LPWA 4 N1-T1	4	9	5 1/4	7 1/2	(8) 5/8-11	3 3/4	14 1/2	16 1/2	12 1/2	16	7 3/8	4 5/16	5 9/16	11 1/2	31	45	
4 inch	LPWA 4 N1-T2	4	7 1/4	4 3/4	5 1/4	(6) 3/8-16	3 3/4	14 1/2	16 1/2	12 1/2	16	7 3/8	4 5/16	5 9/16	11 1/2	31	45	
4 inch	LPWA 4 N5-T1	4	9	5 1/4	7 1/2	(8) Slotted	7 3/4	14 1/2	16 1/2	12 1/2	16	7 3/8	4 5/16	5 9/16	11 1/2	31	45	
6 inch	LPWA 6 N1-T1	6	11	7 1/4	9 1/2	(8) 3/4-10	4	20 5/16	23	14 5/8	16	10 1/2	4 7/16	5 11/16	13 1/2	49	60	
6 inch	LPWA 6 N1-T2	6	9 1/4	6 1/2	8	(8) 3/8-16	4	20 5/16	23	14 5/8	16	10 1/2	4 7/16	5 11/16	13 1/2	49	60	
6 inch	LPWA 6 N5-T1	6	11	7 1/4	9 1/2	(8) Slotted	7 3/4	20 5/16	23	14 5/8	16	10 1/2	4 7/16	5 11/16	13 1/2	49	60	
8 inch	LPWA 8 N1-T1	8	13 1/2	9	11 3/4	(8) 3/4-10	6 5/8	25 5/16	28 1/4	21 1/2	16	12 3/8	4 7/16	6 5/16	13 1/2	55	66	
8 inch	LPWA 8 N5-T1	8	13 1/2	9	11 3/4	(8) Slotted	7 7/8	25 5/16	28 1/4	21 1/2	16	12 3/8	4 7/16	6 5/16	13 1/2	55	66	
10 inch	LPWA 10 N1-T1	10	16	11	14 1/4	(12) 7/8-9	6 5/8	30 5/8	33	25	21	16 1/2	5 5/16	3 3/8	15 1/2	109	130	
10 inch	LPWA 10 N5-T1	10	16	11	14 1/4	(12) Slotted	8 5/8	30 5/8	33	25	21	16 1/2	5 5/16	3 3/8	15 1/2	109	130	
12 inch	LPWA 12 N1-T1	12	19	13	17	(12) 7/8-9	6 5/8	31 5/8	34 1/2	25	21	16 1/2	5 5/16	3 3/8	15 1/2	129	150	
12 inch	LPWA 12 N5-T1	12	19	13	17	(12) Slotted	8 5/8	31 5/8	34 1/2	25	21	16 1/2	5 5/16	3 3/8	15 1/2	129	150	



Vacuum Research valves are available with dozens of options to allow you to select exactly the features you need for your vacuum system. The model number system illustrated below will accurately describe most valves, but if you have any questions about the best way to specify what you need, just call or fax our customer service department and we will be happy to help you. All Valves are (RoHS) 2015/863/EU Compliant.

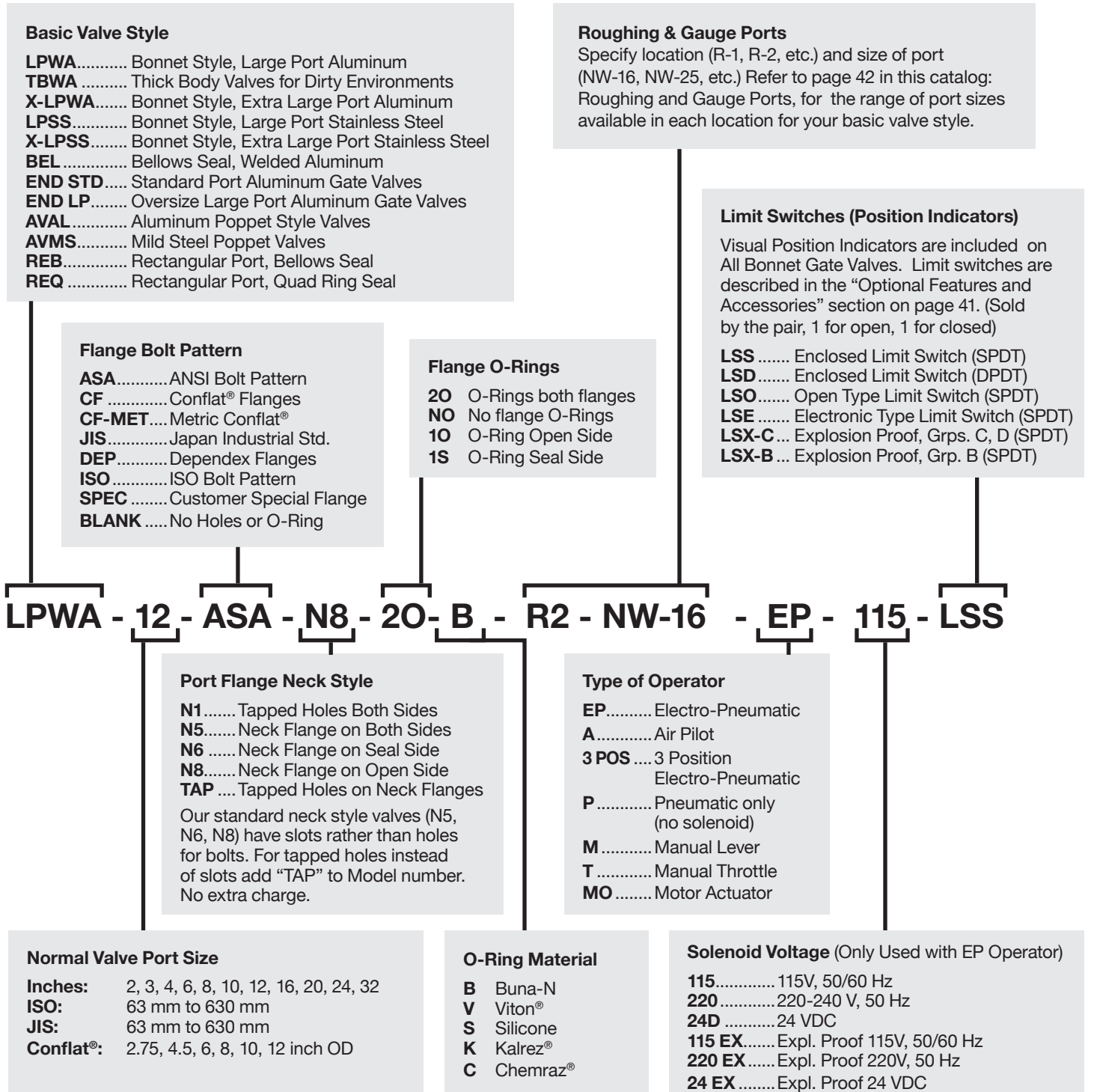

Call our toll free number (800) 426-9340, or (412) 261-7630 to place orders or for customer service. Our FAX number is (412) 261-7220. Address orders by mail to Vacuum Research Corporation, 100 Chapel Harbor Drive, #4, Pittsburgh, PA 15238 USA. Prices in this catalog are FOB factory. CIF or C&F prices available. Contact factory for pro forma invoice or price quotation. Terms are Net 30 days.



Throttlemaster™ is a registered trademark of Vacuum Research Corporation • Kalrez® and Viton® are registered trademarks of Dupont Corp. • Conflat® is a registered trademark of Varian Associates • Chemraz® is a registered trademark of Green, Tweed & Co. • SolidWorks logo art property of Dassault Systèmes.