

# Gauges in Explosion Proof Enclosures, Class 1, Div. 1, ATEX Certificate

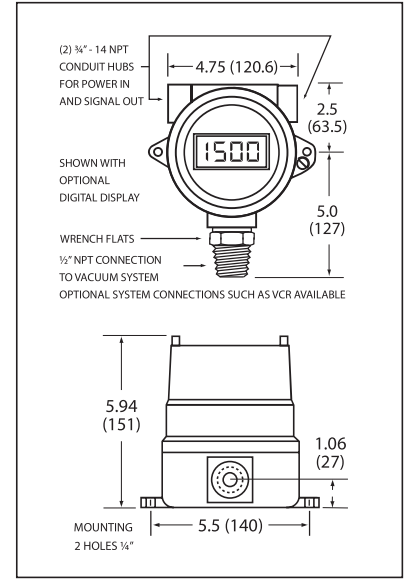

Sensor and gauge with & without optional digital display. Both provide 4 - 20 mA and 0-10 VDC output. Enclosures meet ATEX 95 equipment directive 94/9/EC requirements for Apparatus Group II, Categories 2G/2D: II 2 G EEx e II T3-T4; II 2 G EEx D IIC T3-T4; II 2 D IP66 TI 10°C - T140°C.

VRC offers two approaches to measuring high vacuum in hazardous areas. The first is with the sensor, gauge and optional display built into a Killark enclosure approved by UL, CSA and FM. ATEX certificate is provided with all gauges. All gauges provide both 4-20 mA and 0-10 VDC linear outputs. The alternate approach described at the bottom of this page is to have only the sensor located in the hazardous area with the gauge and display located in a non-hazardous area that can be up to 500 feet away. Power required is 15 to 35 VDC.



## Ordering Information: Gauge, Sensor and Optional Display

Measurement Range, Sensor Type	Maximum Working Pressure	Performance Specifications Catalog Page	Gauge & Sensor with Display & 4-20, 0-10 V Analog Output		Gauge & Sensor with 4-20, 0-10 V Output but No Display		Replacement Sensor Only	
			Part No.	Price	Part No.	Price	Part No.	Price
0.01 to 100 mTorr; Pirani	300 PSIG	14, 24	913050	\$1814	913056	\$1467	902049	\$236
1 to 2000 mTorr; Pirani	300 PSIG	15, 17, 24	913051	\$1691	913057	\$1336	902077XP	\$181
0.01 to 20.00 Torr; Pirani	300 PSIG	16, 17, 24	913052	\$1691	913058	\$1336	902089XP	\$181
1 to 1500 Torr; 316L Diaph.	30 PSIG	9, 17, 24	913053	\$1829	913059	\$1483	902079XP	\$640
-30" Hg to 150 PSIG; 316 Diaph.	150 PSIG	10, 17, 24	913054	\$1829	913060	\$1483	902086	\$640
0.1 to 200 PSIG; 316L Diaph.-30"	300 PSIG	11	913055	\$1829	913061	\$1483	902088	\$640

## Sensors for Hazardous Areas



These explosion proof Diaphragm and Pirani sensors can be used with any of the indicators and controllers described in this catalog. These sensors are complete and ready to install in any Class 1, Group C or D, Div. 1 area. Simply select the range that fits your application from the table below. Like standard Vacuum Research sensors, these explosion-proof sensors are unaffected by lead length and can be located up to 500 feet (150 m) from the display unit.

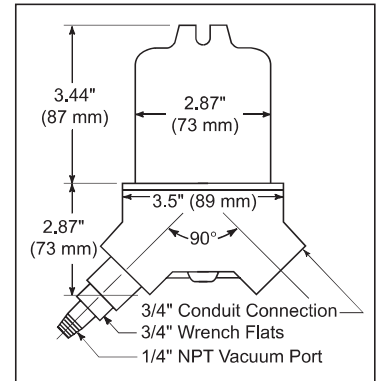

## Ordering Information

Measurement Range	Sensor Type	Performance Specifications Catalog Page	Maximum Working Pressure	Complete Enclosure with Sensor: 1/4" NPT standard, 1/2" NPT optional		Replacement Sensor Only	
				Part No.	Price	Part No.	Price
1 to 2000 mTorr	Pirani	15, 17, 24	300 PSIG	913006	\$1020	902077XP	\$181
.01 to 20 Torr	Pirani	16, 17, 24	300 PSIG	913007	\$1020	902089XP	\$181
1 to 1500 Torr	316L Diaph.	9, 17, 24	30 PSIG	913001	\$1699	902079XP	\$640
-30" Hg to 150 PSIG	316L Diaph.	10, 17	150 PSIG	913003	\$1699	902086	\$640
0.1 to 200 PSIG	316L Diaph.	11	300 PSIG	913005	\$1435	902088	\$640