

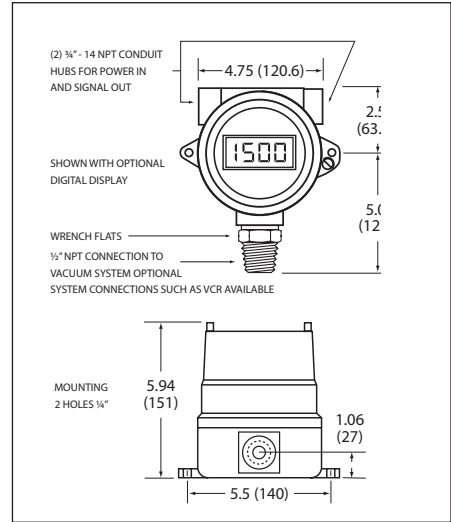

Dust and Water Proof Enclosure Rated IP-65

Available in 3 Ranges

- 1 to 1500 Torr Stainless Steel Diaphragm
- 1 to 2000 mTorr & .01 to 20 Torr Pirani Gauges
- Linear 0 to 10 VDC and 4-20 mA Outputs
- Power Required 12 to 35 Volt DC, 200 mA



SS Diaphragm Gauge 1 to 1500 Torr 1 to 2000 mbar 0.1 to 200 kPa

Specifications

Measurement Range: 1 to 1500 Torr (1 to 2000 mbar and 0.1 to 200 kPa).

Calibration: Any gas.

Resolution: ± 1 Torr.

Response Time: Less than 1 sec. for 90% of an increase in pressure. ≈ 1.5 sec. for decrease from atmosphere to 1 Torr.

Power: 12 to 35 volt DC; less than 100 mA.

Analog Output: Linear 0 to 10 V and 4 to 20 mA standard.

Temperature Effects: Automatic compensation from 0° to 35 °C.

Bake Out Temperature: Gauge can be baked to 100°C (212 oF) in air or vacuum.

Vacuum Connection: 1/4 NPT male. Others such as NW, VCR and 1/2" O.D. tube available.

Materials: All wetted parts 300 series S.S.

SS Sensor Max. Pressure w/o Damage: 4,500 Torr, burst 6,000 Torr.

Dimensions: Enclosure 3 X 3 X 2 In. 1/4 In. NPT. vacuum connection is 1 5/8 In. (41 mm) long.

Mounting: Gauge can be supported by the vacuum connection and oriented in any plane.

Net Wt.: 0.75 lb. (0.3 kg) Ship: 1 lb. (0.45 kg)

Pirani Gauge 1 to 2000 milli Torr 0.001 to 2.000 mbar 0.1 to 200.0 Pa

Specifications

Measurement Range: 1 to 2000 milli Torr (.001 to 2 mbar, and 0.1 to 200 Pa)

Calibration: Air or Nitrogen.

Accuracy: Better than 5% of value or ± 3 mTorr, whichever is larger.

Response Time: 0.3 second time constant.

Power: 12 to 35 volt DC; less than 200 mA.

Analog Output: Linear 0 to 10 VDC & 4 to 20 mA standard.

Temperature Effects: Changes in ambient temperature between 0°C and 50°C change the reading less than 0.2 mT per C° at 50 mT; less than 4 mT per C° at 900 mT.

Bakeout Temperature: Gauge can be baked to 100°C (212°F) in air or vacuum.

Vacuum Connection: 1/4 NPT male. Others such as NW, VCR and 1/2" O.D. tube available.

Dimensions: Enclosure 3 X 3 X 2 In. (76 X 76 X 50 mm) 1/4 In. NPT vacuum connection is 1 5/8 In. (41 mm) long.

Mounting: Gauge can be supported by the vacuum connection and oriented in any plane.

Net Wt.: 0.75 lb. (0.3 kg) Ship: 1 lb. (0.45 kg)

Pirani Gauge .01 to 20 Torr 0.01 to 20.00 mbar 1.0 to 2000 Pa

Specifications

Measurement Range: 0.01 to 20 Torr (.01 to 20 mbar, and 1 to 2000 Pa)

Calibration: Air or Nitrogen.

Accuracy: Better than 5% of value or ± 0.03 Torr, whichever is larger.

Response Time: 0.3 second time constant.

Power: 12 to 35 volt DC; less than 200 mA.

Analog Output: 0 to 10 VDC, non-linear standard. Linear 0-10 V & 4-20 mA optional.

Temperature Effects: Changes in ambient temperature between 0°C and 50°C change the reading less than 0.01 Torr per C°.

Bakeout Temperature: Gauge tube can be baked to 100°C (212°F) in air or vacuum.

Vacuum Connection: 1/4 NPT male. Others such as NW, VCR and 1/2" O.D. tube are available.

Dimensions: Enclosure 3 X 3 X 2 In. (76 X 76 X 50 mm) 1/4 In. NPT vacuum connection is 1 5/8 In. (41 mm) long.

Mounting: Gauge can be supported by the vacuum connection and oriented in any plane.

Net Wt.: 0.75 lb. (0.3 kg) Ship: 1 lb. (0.45 kg)

BUY NOW! Go to www.vacuumresearch.com to order online

Ordering Information

1 to 1500 Torr Stainless Steel Diaphragm Vacuum Transducer. 12 to 35 VDC power. IP-65 dust & water proof enclosure. 1/4 In. NPT Vacuum Connection. Others such as NW, VCR and 1/2 In. O.D. tube available. Linear 0 to 10 VDC and 4 to 20 mA output.

P/N: 912384-Torr (1 to 1500 Torr).....\$796

P/N: 912384-mbar (1 to 2000 mbar)\$796

P/N: 912384-Pa (0.1 to 200.0 kPa).....\$796

Ordering Information

1 to 2000 mTorr Vacuum Transducer. 12 to 35 VDC power IP-65 dust & water proof enclosure. 1/4 In. NPT Vacuum Connection. Others such as NW, VCR and 1/2 In. O.D. tube available. Linear outputs of 0 to 10 VDC and 4 to 20 mA.

P/N: 912365-mTorr(1 to 2000 mTorr)\$574

P/N: 912365-mbar (0.001 to 2000 mbar).....\$574

P/N: 912365-Pa (0.1 to 200.0 Pa).....\$574

Ordering Information

0.01 to 20 Torr Vacuum Transducer. 12 to 35 VDC power IP-65 dust & water proof enclosure. 1/4 In. NPT Vacuum Connection. Others such as NW, VCR and 1/2 In. O.D. tube available. Linear outputs of 0 to 10 VDC and 4 to 20 mA.

P/N: 912367-Torr (0.01 to 20 Torr)\$574

P/N: 912367-mbar (0.01 to 20.00 mbar)\$574

P/N: 912367-Pa (1 to 2000 Pa).....\$574